

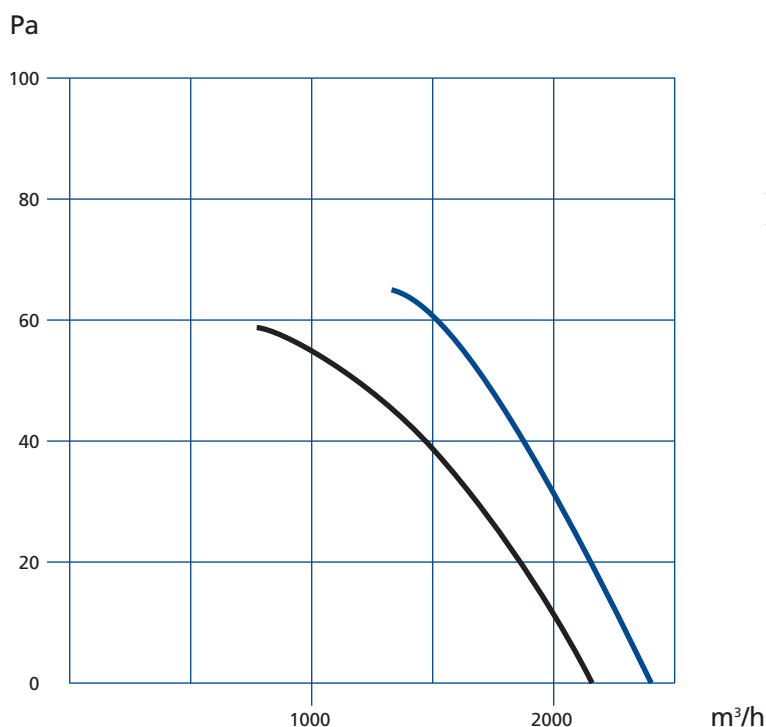

Ventilatore Assiale Ø 350 mm
Tipo: 6M350, 6 poli, monofase
Codice: XR1136M-A0355AB
Materiale: Pale in Acciaio verniciato
Tipo di protezione: IP54

Axial Fan Ø 350 mm
Type: 6M350, 6-pole, single-phase
Code: XR1136M-A0355AB
Material: Sheet steel, black coat
Type of protection: IP54

Tipo Type	Codice Code	Voltaggio Voltage	Frequenza Frequency	Flusso aria Air flow	Velocità Speed	Potenza massima Max power input	Corrente Current draw	Condensatore Capacitor	Liv. rumore Noise level	Max temp. amb. Perm. amb. temp.	Peso Weight
		V	Hz	m ³ /h	RPM	W	A	µ F/VDB	dB(A)	°C	Kg
6M 350	XR1136M-A0355AB	230	50	2100	930	75	0,32	2/400	52	60	3.6
6M 350	XR1136M-A0355AB 60Hz	230	60	2380	1030	90	0,38	2/400	56	60	3.6



Caratteristiche:
 Pressione statica (Pa) - Portata d'aria (m³/h)

Performance data:
 Static pressure (Pa) - Air flow (m³/h)

Codice - Code	Flusso d'aria - Air flow	
XR1136M-A0355AB	Direzione flusso d'aria - Air flow direction	← A

Caratteristiche e dimensioni - Features and dimensions

Ventilatore assiale senza supporto griglia di protezione

Axial fan without protection grill

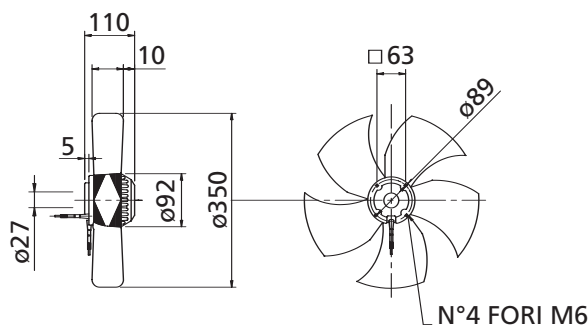

Ventilatore assiale con supporto griglia di protezione a cestello

Materiale: Filo d'acciaio deccappato e verniciato a polvere con resina epossidica

Griglia a cestello codice: XBG-350-01

Axial fan, with basket protection grill

Material: Phosphatized steel wire

Basket grill code: XBG-350-01

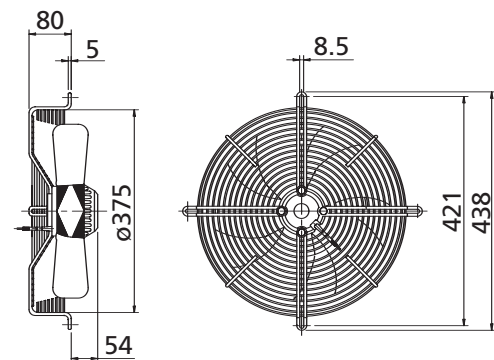

Scatola terminali: Materiale ABS
Tipo di protezione: IP54
Codice: TB-01

Terminal box: ABS
Type of protection: IP54
Code: TB-01

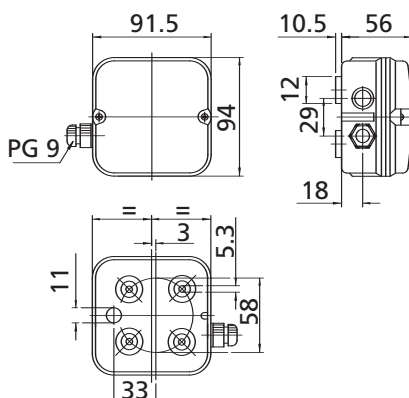

Ventilatore assiale con supporto griglia di protezione a cestello e convogliatore

Materiale: Filo d'acciaio deccappato e verniciato a polvere con resina epossidica - **Convogliatore:** acciaio

Griglia a cestello e convogliatore codice: XBGW-350-01

Axial fan, with basket protection grill and wall plate

Material: Phosphatized steel wire - **Wall plate:** sheet steel

Basket grill with wall plate code: XBGW-350-01

